



## Instruction Manual

# DIGITAL THERMOSTAT Model : PAS3

INP-TN1PAS3-E

## Fuji Electric Co., Ltd.

Head Office  
11-2, Osaki 1-chome, Shinagawa-ku, Tokyo, 141-0032 Japan

## Fuji Electric Instruments Co., Ltd.

Sales Div. International Sales Dept.  
No.1, Fuji-machi, Hino-city, Tokyo, 191-8502 Japan  
Phone : +81-42-585-6201, 6202  
Fax : +81-42-585-6187, 6189  
<http://www.fic-net.co.jp>

Thank you for your purchasing "Fuji DIGITAL THERMOSTAT." Please check that the product is exactly the one you ordered and use it according to the following instructions. (Please refer to a separate operation manual for details.) Dealers are cordially requested to ensure the delivery of this Instruction Manual to hands of the end-users.

### NOTICE

The contents of this document may be changed in the future without prior notice.

We paid the utmost care for the accuracy of the contents. However, we are not liable for direct and indirect damages resulting from incorrect descriptions, omission of information, and use of information in this document.

## CONTENTS

Safety Precautions .....	2	5. Display shifting method .....	12
For normal usage .....	7	6. Functions .....	13
1. Installation/mounting .....	8	7. List of parameters .....	15
2. Wiring .....	9	8. Alarm function .....	17
3. Usage .....	10	9. Error indications .....	19
4. Operation .....	11	Specification .....	19
		PAS3 Model Code .....	19

## Check of specifications and accessories

Before using the controller, check if the type and specifications are as ordered.

Check that all of the following accessories are included in the package box.

- |   |       |        |
|---|-------|--------|
| · Digital thermostat main unit  | ----- | 1 unit |
| · Instruction manual  | ----- | 1 copy |
| · Mounting bracket  | ----- | 1 pce. |
| · Watertight packing  | ----- | 1 pce. |
| · Thermistor sensor (only for the type that the input signal is thermistor)     |       |        |
| Note: The provided thermistor sensor is the sensor dedicated to this equipment. |       |        |



## Details for operation method and the related documents

Contents	Name	No.
Operation method	DIGITAL THERMOSTAT OPERATION MANUAL	ECNO:410
Details of alarm functions	DETAIL DESCRIPTION ABOUT FUNCTIONS OF ALARM OF DIGITAL THERMOSTAT	TN513439-E
Specifications	Catalogue	ECNO:1142

# Safety Precautions

Before using this product, the user is requested to read the following precautions carefully to ensure the safety. Safety precautions must be taken by every user to prevent accidents.

The safety requirements are classified into “warning” and “caution” according to the following interpretations:

 <b>Warning</b>	Suggesting that the user's mishandling can result in personal death or serious injury.
 <b>Caution</b>	Suggesting that the user's mishandling can result in personal injury or damage to the property.

## **WARNING** Over-temperature Protection

“Any control system design should take into account that any part of the system has the potential to fail”.

“The most dangerous condition of the system equipped with this product is continued heating, and the machine should be designed to automatically stop heating even if alarm is not issued at the time of failure of this product or due to any other reason”.

The following are the most common cases where continued heating cannot be detected with this product.

- 1) Failure to issuing an alarm even when this product fails
- 2) Disengagement of the temperature sensor from the system
- 3) A short circuit in the thermocouple wiring

In any application where physical injury or destruction of equipment might occur, we recommend the installation of independent safety equipment, with a separate temperature sensor, to disable the heating circuit in case of overheating.

Digital thermostat alarm signal is not designed to function as a protective measure in case of product failure.

# 1. Warning

## 1.1 Installation and wiring

Operating temperature	0 to +50 [°C ]	
Operating humidity	90%RH or less (Non condensation)	
Installation category	II	Conforming to IEC1010-1
Pollution degree	2	

- This product designed to be installed at the conditions shown in the right table.
- If there is a danger of a serious accident resulting from a failure or a defect in this unit, provide the unit with an appropriate external protective circuit to prevent an accident.
- The unit is supplied without a power switch and fuses.  
Make wiring so that the fuse is placed between the main power supply switch and this product. (Main power supply: 2 pole breaker, fuse rating: 250V, 1A)
- When wiring the power supply terminal, use vinyl insulated 600 volt cable or equivalent.
- To avoid the damage and failure of this product, supply the power voltage fitting to the rating.
- To avoid an electric shock and this product failure, do not turn ON the power before all wiring is completed.
- Be sure to check that the distance is kept to avoid electric shock or firing before turning the power ON.
- Keep away from terminals while the circuit is energized in order to avoid an electric shock and a malfunction.
- Never attempt to disassemble, fabricate, modify, or repair this unit because tampering with the unit may result in a malfunction, electric shock, or a fire.

## 1.2 Maintenance precautions

- Be sure to turn off the power before this product is installed or removed in order to avoid an electric shock, malfunction, and fault.
- Regular maintenance is recommended a longer service life of this controller. Some parts of this controller have a limited life span, or they will be deteriorated with the lapse of time.
- One-year warranty is guaranteed for this unit including accessories, provided that the controller is properly used.

## 2. Caution

### 2.1 Cautions on installation

Avoid the following places for installation.

- A place where the ambient temperature may reach beyond the range of from 0 to 50°C while in operation.
- A place where the ambient humidity may reach beyond the range of from 45 to 85% RH while in operation.
- A place where a change in the ambient temperature is so rapid as to cause condensation.
- A place where corrosive gases (sulfide gas and ammonia gas, in particular) or combustible gases are emitted.
- A place where the unit is subject directly to vibration or shock. (vibration or shock may cause malfunction of the output relay.)
- A place exposed to water oil, chemicals, steam and vapor.  
(if immersed with water, take the inspection by sales office to avoid an electrical leakage and firing )
- A place where the unit is exposed to dust, salt air, or air containing iron particles.
- A place where the unit is subject to interference with static electricity, magnetism, and noise.
- A place where the unit is exposed to direct sunlight.
- A place where the heat may be accumulated due to the radiation of heat.

### 2.2 Cautions on installation on panel

- Insert the mounting bracket (accessory) from the rear side until the main unit is securely fit into the panel. If there should be a play, tighten two screws lightly until the play is eliminated. (Do not tighten the screws excessively because the mounting bracket can be removed from the stopper by the force.)
  - The front side of product to NEMA 4X (equivalent with IP66). To ensure the waterproofness between the instrument and the panel, use packings that are provided as accessories in the following manner: (The improper fitting of packings will ruin the waterproofness.)
    - ① As shown in Figure 1, fit a packing to the case of the unit and then insert it in the panel.
    - ② Tighten screws on the fixing frame or fixtures so that no gaps are given between the front of controller and packing and between panels.
- Check that there are no deviation and deformation of packing as shown in Fig.3.
- If panel strength is weak, it may generate a gap between the packing and the panel, thus impairing water resistance.

Installation

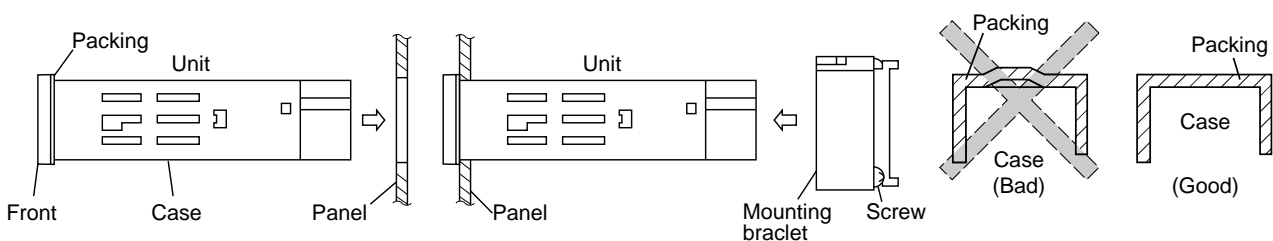

Figure 1

Figure 2

Figure 3

(Caution)

- Don't block the openings around this product, or radiation effect will be reduced.
- Don't block the ventilation openings at the top of the terminal block.

Standard : Vertical mounting, flush on the panel. (This product is horizontal.)

When mounting this product on tilted surface, the maximum tilt angle is 30° (degree) from vertical.

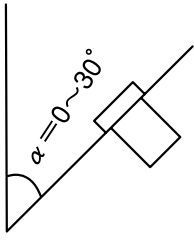

## 2.3 Precautions in wiring connection

- For the thermocouple sensor type, use thermocouple compensation wires for wiring.
- Keep input lines away from power line and load line to avoid the influence from noise induced.
- For the input and output signal lines, be sure to use shielded wires and keep them away from each other.
- If a noise level is excessive in the power supply, the additional installation of an insulating transformer and the use of a noise filter are recommended. (example: ZMB22R5-11 Noise Filter manufactured by TDK)

Make sure that the noise filter is installed to a place such as a panel that is properly grounded. The wiring between the noise filter output terminal and the instrument power supply terminal should be made as short as possible. None of fuses or switches should be installed to the wiring on the noise filter output side because the filter effect will be degraded by such a installation.

- A better anti-noise effect can be expected by using stranded power supply cable for the instrument. (The shorter the stranding pitch is, the better the anti-noise effect can be expected.)
- A setup time is required for the alarm output when the power is turned on. If the alarm output is used as a signal for an external interlock circuit, use a delay relay at the same time.
- Use the auxiliary relay since the life is shortened if full capacity load is connected to the alarm output relay.
- If inductive load such as magnetic switches connected as a alarm output load, it is recommended to use Z-Trap manufactured by Fuji Electric to protect a contact from switching surge and keep a longer life.

Model : ENC241D-05A (power supply voltage: 100 V)

ENC471D-05A (power supply voltage: 200 V)

Where to install : Connect it between contacts of the alarm output.

Example)

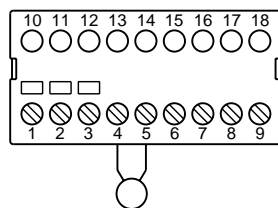

Z-Trap connection

## 2.4 Requirement for key operation/operation in abnormalities

- A display of UUU or LLL will appear in case of a break in the input. Be sure to turn off the power when a sensor is replaced.
- Do not turn OFF the power for at least five (5) seconds if the alarm set value or any parameter was changed.

## 2.5 Others

- Do not use organic solvents such as alcohol and benzine to wipe this controller. Use a neutral detergent for wiping this product.
- Do not bring any mobile phone close to the main unit (50 cm). Malfunction will occur.
- Noise may be produced if this equipment is brought close to a radio. Use this equipment as fully spaced apart from radios.
- Do not push the display unit (LCD) on the front face of this equipment with force. Observation of the display (LCD) will become hard.
- This equipment issues an LCD as the front display. There are cases where the display can be hardly observed at a slant because of the characteristics of LCD.
- Observation of the display (LCD) will become hard when the ambient temperature drops to a level close to 0°C.

# For normal usage

<Reference items>	<Description>	<Remarks>
Confirming type specification	<ul style="list-style-type: none"> <li>• Confirming that the delivered product is equal to the ordered one.</li> </ul>	
↓		
1   Installation/mounting	<ul style="list-style-type: none"> <li>• Outline dimensions</li> <li>• Panel cutout dimensions</li> <li>• Mounting method on the panel</li> </ul>	<ul style="list-style-type: none"> <li>• Read "Safety Precautions"</li> </ul>
↓		
2   Wiring	<ul style="list-style-type: none"> <li>• Terminal connection diagram</li> </ul>	<ul style="list-style-type: none"> <li>• Read "Safety Precautions"</li> </ul>
↓		
Power on		<ul style="list-style-type: none"> <li>• To start the operation, wait for about 15 minutes after the power-on for warm up.</li> </ul>
↓		
3   Usages		
4   Operation	<ul style="list-style-type: none"> <li>• Basic operation method</li> <li>• Set value change method</li> </ul>	
5   Display shift		
6   Details of parameters	<ul style="list-style-type: none"> <li>• List of input/alarm codes</li> </ul>	
7   List of parameters	<ul style="list-style-type: none"> <li>• Names and functions of parameters</li> </ul>	
8   Alarm functions		
↓		
Operation		
↓		
9   Error indication	<ul style="list-style-type: none"> <li>• Display when abnormal</li> </ul>	

# 1

# Installation/mounting

## Outline and Panel Cutout Dimensions

Outline dimensions (Unit : mm)

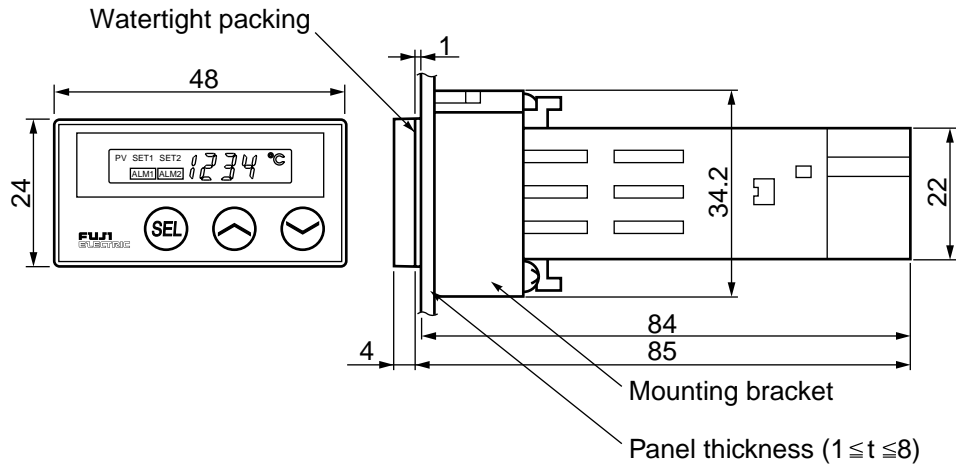

Panel cutout dimensions (Unit : mm)

For separate mounting

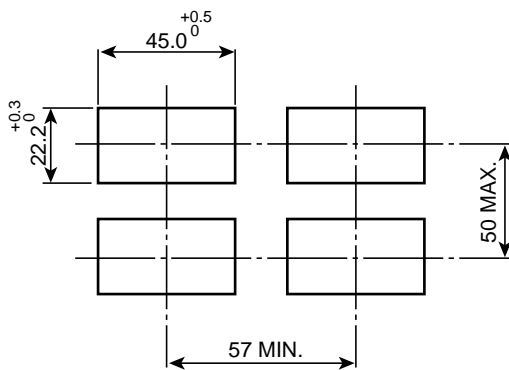

For mounting close together (n controllers)

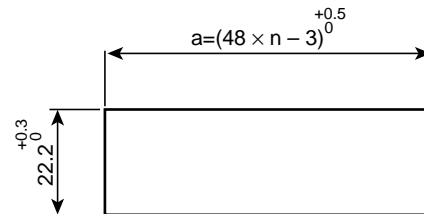

Number of units	2	3	4	5	6
a	93	141	189	237	285

Note: Watertight feature is unavailable if mounted close together.



# 2

# Wiring

## Terminal Connection Diagram (100 to 240 Vac)

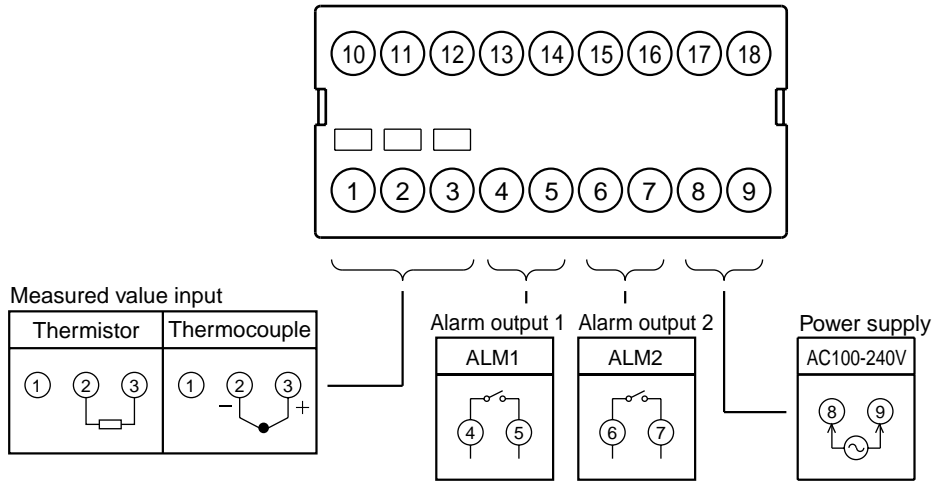

Note 1) Check the power supply voltage before installation.

Note 2) Tighten the terminal screw securely with fastening torque of 0.4N·m.

## Designation of Wiring Material

- Wire

Gauge: AWG28 (0.1mm<sup>2</sup>) to AWG16 (1.25mm<sup>2</sup>)

Strip-off length: 5 to 6 mm

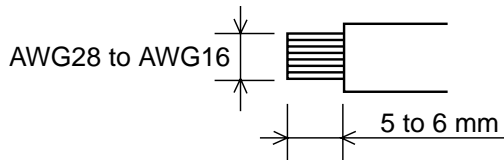

- Rod terminal

Dimension of exposed conductor section:

2 x 1.5 mm or smaller

Length of exposed conductor section:

5 to 6 mm

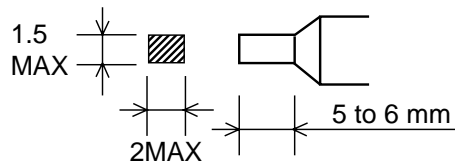

**Caution**

To prevent disconnection or short circuit, never use the wire other than the one stated above, and make sure to insert it toward the back of the terminal block.

Fastening torque: 0.4N·m

### 3 Usage (Read before using)

#### Name of Functional Parts and Functions

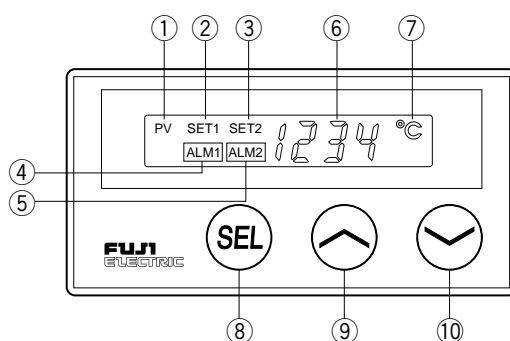

#### Display/Indication

	Name	Function
①	Process value (PV) indicator	The lamp is lit while a process value (PV) is displayed.
②	Alarm set value 1 (SET 1)	The lamp is lit while an alarm set value 1 is displayed.
③	Alarm set value 2 (SET 2)	The lamp is lit while an alarm set value 2 is displayed.
④	Alarm 1 (ALM1) indicator	The lamp is lit when the alarm 1 occurred.
⑤	Alarm 2 (ALM2) indicator	The lamp is lit when the alarm 2 occurred.
⑥	Display of process value (PV)/ alarm set value 1 (SET1)/ alarm set value 2 (SET2)/ parameter name or parameter set value	1) Process value, alarm set value 1 or alarm set value 2 is displayed in the Operation mode (level 1). 2) Parameter name or set value is displayed at the time of setup of various parameters (level 2, 3, 4). 3) Various warnings are displayed on occurrence of errors. See "9. Error indications" for the display on occurrence of errors. Note: Process value and alarm set value are of 1°C units.
⑦	Unit display	Lit only in the running state (level 1).

Note) Alarm output 2 is optional.

#### Setting keys

	Name	Function
⑧	Select key	Used for switching of display between process value and alarm set value, level move, switching to parameter setting mode and for data registration.
⑨	Up key	<ul style="list-style-type: none"> <li>Used for parameter shifting (returning) or data changing (increasing).</li> <li>The numerical value is increased by pressing the key once. The numerical value keeps on increasing by pressing the key continuously.</li> </ul>
⑩	Down key	<ul style="list-style-type: none"> <li>Used for parameter shifting (to next) or data changing (decreasing).</li> <li>The numerical value is decreased by pressing the key once. The numerical value keeps on decreasing by pressing the key continuously.</li> </ul>

# 4 Operation

## Parameter setting mode (level 2, level 3, level 4)

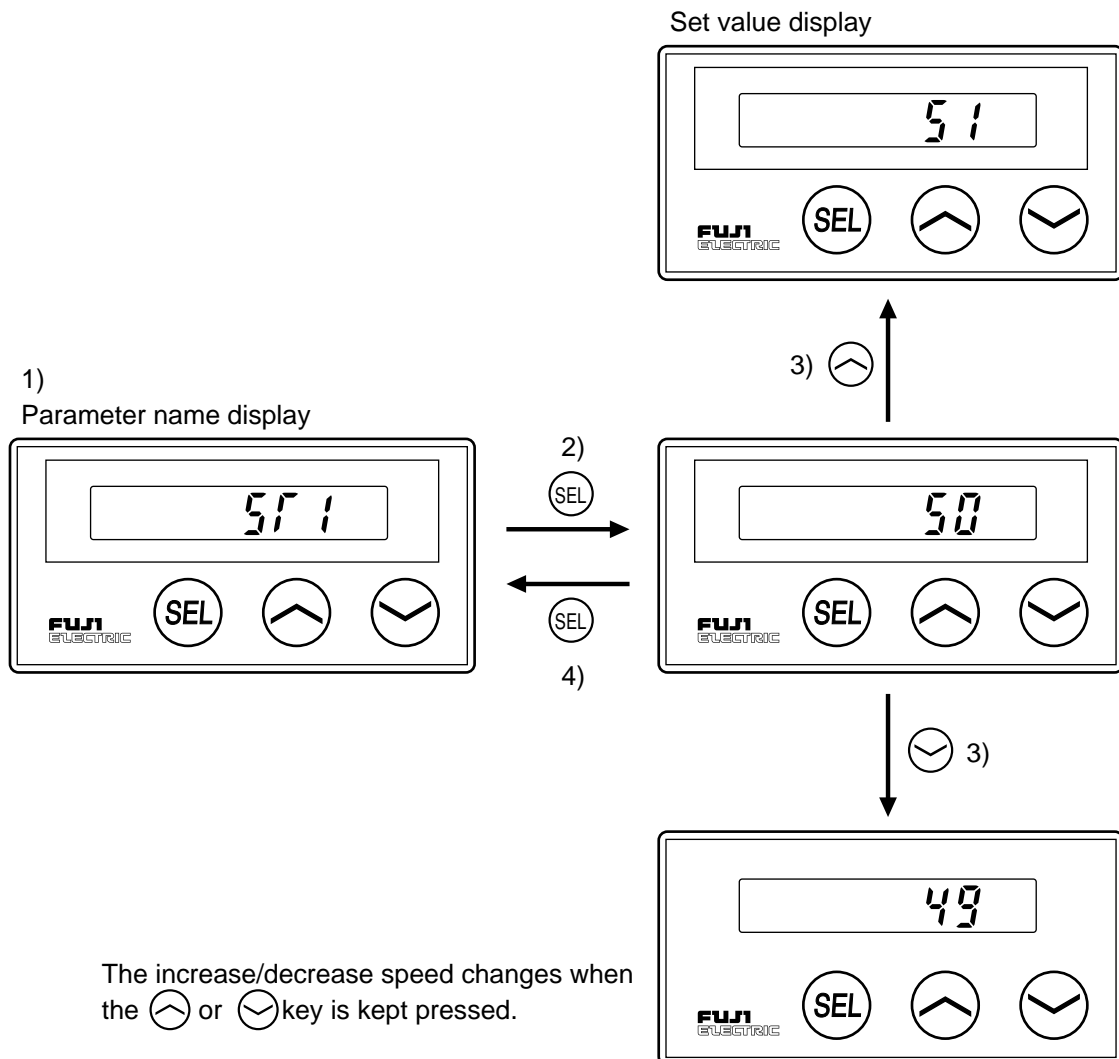

### <Parameter setting procedure>

- 1) Select a parameter you want to set by pressing the or key.
- 2) Press the key to display the parameter set value.
- 3) Pressing the or key, to change the parameter set value.
- 4) After the parameter has been changed, press the key for registration.

### <Method for move of level 1>

- 1) To move to the running state (level 1) from the parameter setting state (level 2, 3, 4), press the key for 3 seconds in the parameter name displayed state.

**Caution** 1) When a period of 3 seconds has elapsed since the parameter set value was changed, the data is registered even if the key is not pressed.

# 5

# Display shifting method

## Operation mode (level 1)

### 1 Changing of the level 1 indication

**1-1** When indicating the process value (PV)

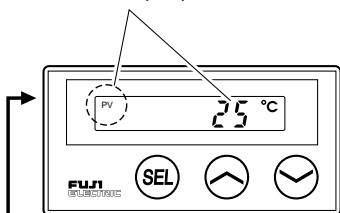

Press the (SEL) once

**1-2** When indicating the alarm set value 1 (SET 1)

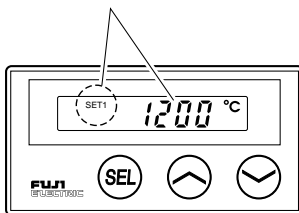

Press the (SEL) once

**1-3** When indicating the alarm set value 2 (SET 2)

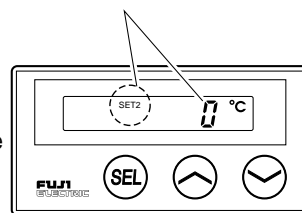

Press the (SEL) once

- Caution**
- 1) Select the level to which move is to occur by the length of time during which the "SEL" key is pressed.
  - 2) Setup of the alarm set value cannot be changed at level 1. Change the alarm set value by parameters ST1, ST2 of level 2.
  - 3) The display returns to the running state (level 1/PV display) if the non-operated state continues for 30 seconds.

Press (SEL) for about 3 second. Then, returns to the process value (PV) indication.

Press (SEL) for about 3 second.

Press (SEL) for about 3 second. Then, returns to the process value (PV) indication.

Press (SEL) for about 7 second.

Press (SEL) for about 3 second. Then, returns to the process value (PV) indication.

Press (SEL) for about 9 second.

### Level 2 parameter block

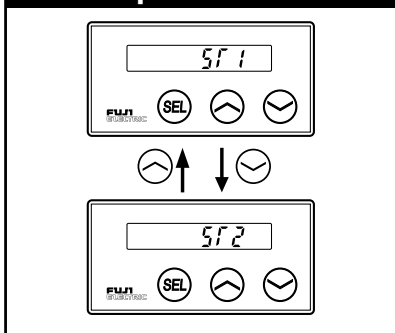

### Level 3 parameter block

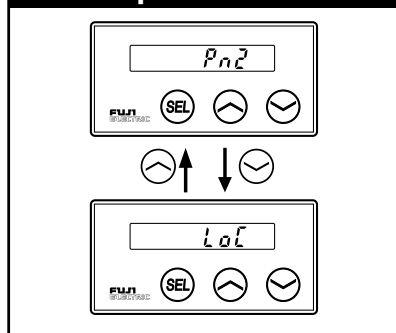



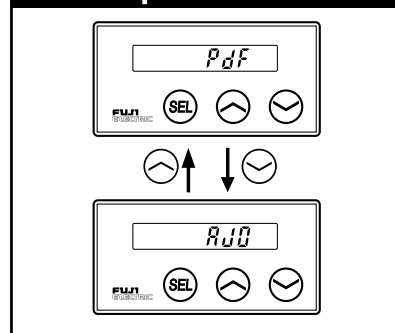

### Level 4 parameter block

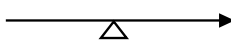

## 6 Functions

**[Table 1] Alarm action type code**

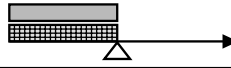
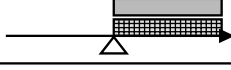
**Parameters: PA1, PA2**

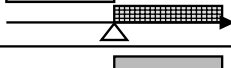
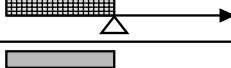
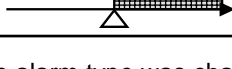
Code of PA1 and 2	Alarm type	Set value	Hold function	Relay operation at alarm	Action diagram
0	No alarm	If activation of either one of alarms is not wanted when 2-point alarm is used, set "0" as its alarm activation type.			
1	Upper limit	Absolute value	Without	Relay energization	
2	Lower limit	Absolute value	Without	Relay energization	
3	Upper limit	Absolute value	With	Relay energization	
4	Lower limit	Absolute value	With	Relay energization	
5	Upper limit	Absolute value	Without	Relay de-energization	
6	Lower limit	Absolute value	Without	Relay de-energization	
7	Upper limit	Absolute value	With	Relay de-energization	
8	Lower limit	Absolute value	With	Relay de-energization	

**Caution** Turn OFF/ON the power for the main unit once after the alarm type was changed.

(How to read activation diagram)

 area: Range in which "ALM1 or ALM2" indicator is displayed on the LCD on the front face

 area: Range in which the alarm relay is energized

△point: Alarm set value

The horizontal represents PV.

## [Table 2] Input range, input code

### Parameters: Pn2, PSL, PSU



Input signal	Code of Pn2	Range (°C)	Limiting resolution	Indication accuracy	
Thermo-couple	J	2	0 to 800	1°C	±3°C
	K	3	0 to 1200	1°C	±3°C
	R	4	0 to 1600	4°C	±4°C
	T	6	0 to 400	1°C	±3°C
	E	7	0 to 600	1°C	±3°C
Thermistor	PB-36	8	0 to 100	1°C	±4°C

#### **Caution**

- 1) Correct display is not made in the range of 0 - 500°C of R thermostat.
- 2) It is not permitted to make switching between thermistor input and thermocouple input. (It is fixed depending on what was specified at the time of purchase.)
- 3) If the input signal was changed, the measuring range should be changed to a value that corresponds to the input signal. (Set PSL at 0 and set PSU at the upper limit value of the measuring range.)
- 4) The accuracy of indication of the thermocouple does not include the accuracy of zero contact compensation (±3°C).
- 5) The accuracy of indication of thermistor input does not include the accuracy of the sensor.

# 7 List of parameters

Level	Parameter indication	Parameter name	Function	Default setting	Remarks	
Level 2	ST1	<i>ST1</i>	Alarm set value 1 setup	Set the alarm 1 activation value. It may be set within the input range.	100%	Note1 Table2
	ST2	<i>ST2</i>	Alarm set value 2 setup	Set the alarm 2 activation value. It may be set within the input range.	0%	Note1 Table2
Level 3	Pn2	<i>Pn2</i>	Input type	Selection of input type	3	
	PSL	<i>PSL</i>	Range lower limit setup	Setup of lower limit of the input range (set range: 0-1999)	0	
	PSU	<i>PSU</i>	Range upper limit setup	Setup of upper limit of the input range (set range: 0-1999)	1200	
	PA1	<i>PA1</i>	Alarm type 1	Select the type of alarm activation. (set range: 0-8)	1	Table1
	PA2	<i>PA2</i>	Alarm type 2		2	Table1
	HY1	<i>HY1</i>	Alarm 1 hysteresis width	Set the ON/OFF hysteresis width of the alarm output. (set range: 0-110%FS of the input range)	1	Note2
	HY2	<i>HY2</i>	Alarm 2 hysteresis width		1	Note2
	Pd1	<i>Pd1</i>	Alarm 1 ON delay time	Set ON delay of the alarm output. (set range: 0-120 seconds)	0	
	Pd2	<i>Pd2</i>	Alarm 2 ON delay time		0	
	brn	<i>brn</i>	Burn-out direction	Set the swinging direction at the time of burn-out. (set range: upper limit = H, lower limit = L)	H	
	oPd	<i>oPd</i>	Power ON delay time	Setup of power ON delay time power ON delay: Delay time until output inhibition is canceled after power ON (set range: 0-120 seconds)	0	
	LoC	<i>LoC</i>	Setup lock	Select whether parameter setup change is permitted or not. LoC = 0: Setup change is permitted for all parameters. LoC = 1: No setup change is permitted for all parameters. LoC = 2: Alarm set value 1 (ST1) and alarm set value 2 (ST2) only may be set.	0	
Level 4	PdF	<i>PdF</i>	Input filter time constant	Set the time constant. (set range: 0-90 seconds)	5	
	POF	<i>POF</i>	PV offset	Shift the display of the process value (PV). (set range: -10-10%FS of the input range)	0	Note1,2
	AJO	<i>AJO</i>	User ZERO adjustment	Shift the input ZERO side. (set range: -50-50%FS of the input range)	0	Note1,2
	AJS	<i>AJS</i>	User SPAN adjustment	Shift the input SPAN side. (set range: -50-50%FS of the input range)	0	Note1,2

- Caution** 1) If the unit of setup of a parameter is engineering value or deviated engineering value, the value of such a parameter changes accompanying change to PSL and PSU. (Indicated by ) .)
- \* Values of input range 100% = PSU, input range 0% = PSL
- 2) FS (full scale) means the value of PSU - PSL. (Example: 50% FS =  $(1200 - 0) \times \frac{50}{100}$ , when PSL = 0 and PSU = 1200)
- 3) There are parameters that are not displayed depending on the type. (Indicated by ) .)
- 4) The accuracy of alarm delay time and of power ON delay time is less than 1 second.
- 5) A difference of 1°C may arise between the indication and the alarm output depending on the range setup.
- (Example: If the alarm set value is 200°C, an alarm occurs when the indication is 200°C in some cases, but an alarm occurs when the indication is 201°C in other cases.)
- 6) There are cases where over-range (UUU) or under-range (LLL) display is not made, if a large value is set as a PV offset, user zero or user span. Be careful.



# 8

# Alarm function

## 1) Kinds of alarm

Absolute value upper limit alarm or absolute lower limit alarm is available. (For details, see Table 1 Alarm action type codes.)

### ON delay function

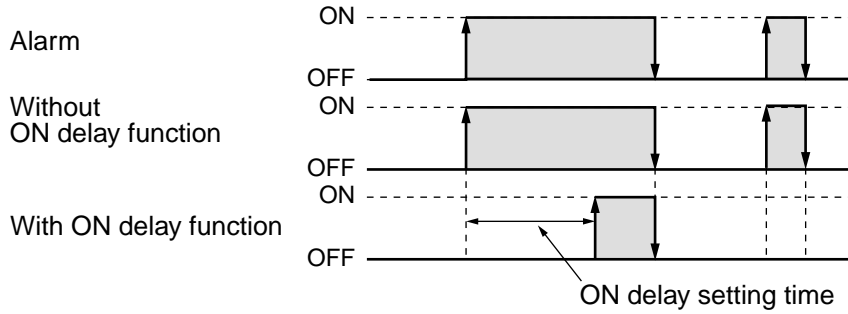

### Energizing/de-energizing function

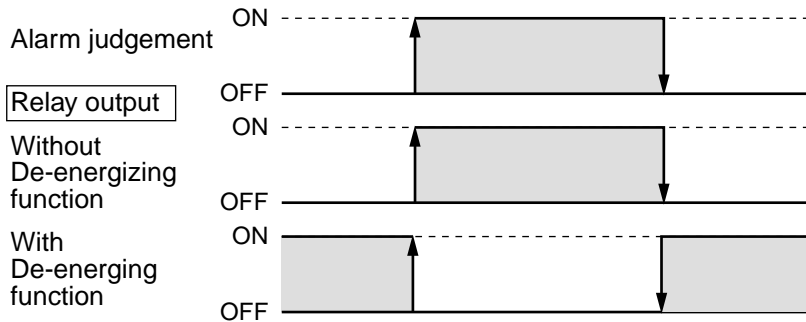

## 2) Function of alarm

**Caution** "Detail description about functions of alarm of Digital Thermostat" is prepared.  
Please inquire us when you use this function.

No.	Function name	Function	Parameters to set
①	Hysteresis function	Activation dead zone (hysteresis) may be set at alarm activation.	Alarm1 : $HY1$ Alarm2 : $HY2$
②	Alarm ON delay function	The alarm is ON when the ON delay set time has elapsed after the alarm ON conditions were satisfied.	Alarm1 : $Pd1$ Alarm2 : $Pd2$
③	Energize/non-energize function	Relay output energize or non-energize can be selected on occurrence of alarm. (See [Table 1] Alarm activation type codes.)	Alarm1 : $PR1$ Alarm2 : $PR2$
④	Power ON delay function	Alarm judgment is not made during the power ON delay time after power ON. (This equipment will not issue an alarm even if the alarming state arises during the power ON delay time.)	$OPd$

**Point** What is alarm with hold?  
The alarm is not turned ON immediately even when the measured value is in the alarm band.  
It turns ON when it goes out the alarm band and enters again.

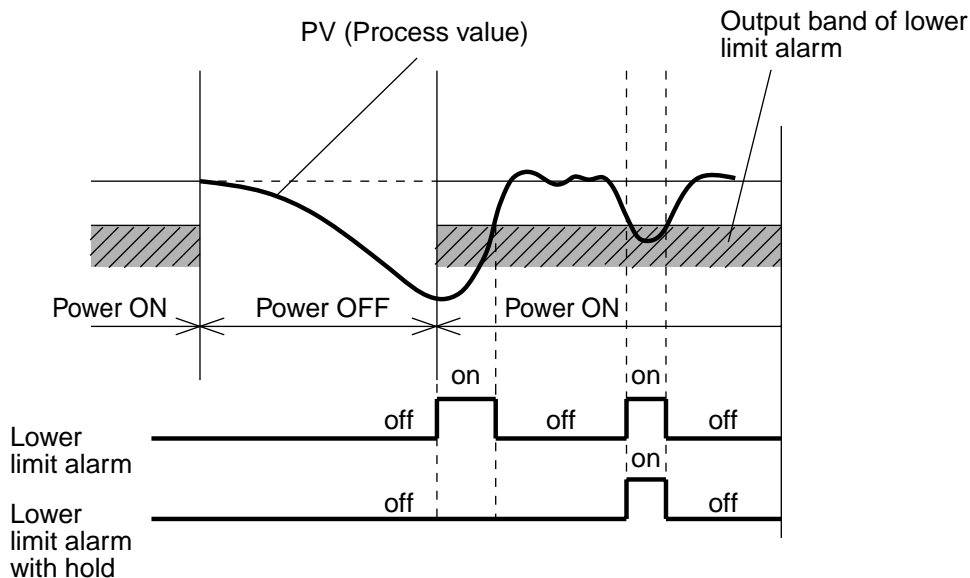

### Caution

No.	Precaution
1	No output is produced while the power is OFF, even if the non-energize function is ON. (It is OFF.)
2	The HOLD function is also value while the PV value is located in the hysteresis area at the time of power ON.
3	Before HOLD is canceled, HOLD is canceled immediate upon entry to the alarm OFF area. After HOLD was canceled, however, ON delay is applied upon entry to the alarm ON area.
4	Alarm delay is also applied on occurrence of an alarm due to burn-out.

# 9

# Error indications

## Error indications

This product has a display function to indicate several types of error code shown below.

If any of the error codes is displayed, please eliminate the cause of error immediately.

After the cause is eliminated, turn off the power once, and then re-start this product.

Error code	Possible cause	Alarm output
UUU	① Thermocouple burnt out. ② PV value exceeds the range upper limit by 5% FS.	<Case of upper limit alarm setup> ① When burn-out direction (brn) is set at lower limit (L) .... OFF ② When burn-out direction (brn) is set at upper limit (H) ..... ON
LLL	① PV value is below the range lower limit by 5%FS. ② Thermistor sensor burnt out.	<Case of lower limit alarm setup> ① When burn-out direction (brn) is set at lower limit (L) ..... ON ② When burn-out direction (brn) is set at upper limit (H) ... OFF
Err	Incorrect range setting (PSL/PSU)	OFF

## Specification

Power voltage:	100 (-15%) to 240 (+10%), 50/60Hz
Power consumption:	3VA or less (100V AC), 6VA or less (220V AC)
Alarm output (Max. 2 points):	Relay contact (SPST contact) 220V AC / 30V DC 2A (resistive load)
Operating ambient temperature:	0 to 50°C, 90%RH or less (no condensation)
Preservation temperature:	-20 to 60°C
Thermistor sensor:	Allowable deviation/±2°C or less, constant value B/3390K±1%, resistance/6kΩ (0°C)

## PAS3 Model Code

Specification			Model code
Input signal	Input range	Alarm points	
Thermocouple (K)	0 to 1200°C	1 point	PAS3K1Y1
		2 points	PAS3K1A1
Thermistor	0 to 100°C	1 point	PAS3H1Y1
		2 points	PAS3H1A1